

# DH-HAC-HDW1200TRQ(-A)

2MP HDCVI Quick-to-install IR Eyeball Camera



- Max 30fps@1080P
- Quick-to-install eyeball saves installation time
- Built-in mic (-A)
- CVI/CVBS/AHD/TVI switchable
- 3.6mm fixed lens (2.8mm optional)
- Max. IR length 25m, Smart IR
- IP50, DC12V



## System Overview

Experience 1080P full HD video and the simplicity of using existing cabling infrastructure with HDCVI. The Lite series 1080P HDCVI camera features a compact design and offers a high quality image at a friendly price. It offers various motorized/fixed lens models with a multi-language OSD and HD/SD switchable output. Its structural flexibility and high cost-performance makes the camera an ideal choice for SMB solutions.

## Functions

### 4 Signals over 1 Coaxial Cable

HDCVI technology supports 4 signals to be transmitted over 1 coaxial cable simultaneously, i.e. video, audio\*, data and power. Dual-way data transmission allows the HDCVI camera to interact with the XVR, such as sending control signal or triggering alarm. Moreover, HDCVI technology supports PoC for construction flexibility.

\* Audio input is available for some models of HDCVI cameras.

### Easy Installation

HDCVI Quick-to-install eyeball adopts quick-to-install pedestal, which can achieve easier installation than conventional eyeball. Quick-to-install camera reduces time and labor costs.

### Long Distance Transmission

HDCVI technology guarantees real-time transmission at long distance without any loss. It supports up to 800m(1080p)/1200m(720P) transmission via coaxial cable, and up to 300m(1080P)/450m(720P) via UTP cable.\*

\*This function is available for select models.

### Simplicity

HDCVI technology inherits the feature of simplicity from traditional analog surveillance system, making itself a best choice for investment protection. HDCVI system can seamlessly upgrade the traditional analog system without replacing existing coaxial cabling. The plug and play approach enables full HD video surveillance without the hassle of configuring a network.

## Smart IR

The camera is designed with IR LED illumination for best lowlight performance. Smart IR is a technology that ensures ensure brightness uniformity in B/W image under low illumination. Dahua's unique Smart IR adjusts to the intensity of camera's infrared LEDs to compensate for the distance of an object, and prevents IR LEDs from overexposing images as the object come closer to the camera.

## Multi-formats

The camera supports multiple video formats including HDCVI, CVBS and other two common HD analog formats in the market. The four formats can be switched over through OSD menu or by PFM820 (UTC controller). This feature makes the camera to be compatible with most end users' existing HD/SD DVRs.









## Multi-language OSD

OSD menu provides multiple image adjustments and function settings to meet the requirements of different monitoring scenes. The OSD menu includes configurations such as backlight mode, day/night, white balance, privacy mask and motion detect. The camera supports 11 languages for OSD menu, namely, Chinese, English, French, German, Spanish, Portuguese, Italian, Japanese, Korean, Russian and Polish.

## Protection

With working temperature range of -40°C to +50°C (-40°F to 122°F), the camera is designed for extreme temperature environments. Supporting ±30% input voltage tolerance, this camera suits even the most unstable power supply conditions. Its 4KV lightning rating provides protection against the camera and its structure from the effects of lightning.

Technical Specification					
<b>Camera</b>					
Image Sensor	1/2.7 inch CMOS				
Max. Resolution	1920(H)×1080(V)				
Pixel	2MP				
Scanning System	Progressive				
Electronic Shutter Speed	PAL: 1/25s–1/100000s NTSC: 1/30s–1/100000s				
S/N Ratio	>65dB				
Min. Illumination	0.02 Lux/F1.9, 30IRE, 0 Lux IR on				
Illumination Distance	25 m (82.0 ft)				
Illuminator On/Off Control	Auto; manual				
Illuminator Number	2 (IR)				
Pan/Tilt/Rotation Range	Pan: 0°–360° Tilt: 0°–78° Rotation: 0°–360°				
<b>Lens</b>					
Lens Type	Fixed-focal				
Mount Type	M12				
Focal Length	2.8 mm; 3.6 mm				
Max. Aperture	2.8 mm: F1.9 3.6 mm: F2.0				
Field of View	2.8 mm: H: 101°; V: 54° ; D: 119° 3.6 mm: H: 84°; V: 45°; D: 100°				
Iris Type	Fixed iris				
Close Focus Distance	2.8 mm: 0.5 m (1.64 ft) 3.6 mm: 0.8 m (2.62 ft)				
DORI Distance	Lens	Detect	Observe	Recognize	Identify
	2.8 mm	38.6 m (126.6 ft)	15.4 m (50.5 ft)	7.7 m (25.3 ft)	3.9 m (12.8 ft)
	3.6 mm	49.7 m (163.1 ft)	19.9 m (65.3 ft)	9.9 m (32.5 ft)	5 m (16.4 ft)
<b>Video</b>					
Frame Rate	CVI: 1080P@25/30fps; 720P@25/30fps; 720P@50/60fps; AHD: 1080P@25/30fps; 720P@25/30fps; TVI: 1080P@25/30fps; 720P@25/30fps; 720P@50/60fps; CVBS: 960H				
Resolution	1080P (1920×1080); 720P (1280×720); 960H (960×576/960×480)				
Day/Night	Auto switch by ICR				
BLC	BLC/HLC/DWDR				
WDR	DWDR				
White Balance	Auto; manual				
Gain Control	Auto; manual				
Noise Reduction	2D NR				
Smart IR	Yes				
Mirror	Off/On				
Privacy Masking	Off/On (8 area, rectangle)				
<b>Certifications</b>					
Certifications	CE (EN55032:2015, EN 61000-3-2:2014, EN 61000-3-3:2013, EN55024:2010+A1:2015, EN 55035:2017, EN50130-4:2011+A1:2014) FCC (CFR 47 FCC Part 15 subpartB, ANSI C63.4-2014) UL (UL60950-1+CAN/CSA C22.2 No.60950-1)				
<b>Port</b>					
Video Output	Video output choices of CVI/TVI/AHD/CVBS by one BNC port				
Audio Interface	Built-in Mic (-A)				
<b>Power</b>					
Power Supply	12V ±30% DC				
Power Consumption	Max 2.6 W (12V DC, IR on)				
<b>Environment</b>					
Operating Temperature	-40°C to +50°C (-40°F to 122°F);<95% (non-condensation)				
Storage Temperature	-40°C to +50°C (-40°F to 122°F);<95% (non-condensation)				
Protection Grade	IP50				
<b>Structure</b>					
Casing	Plastic				
Dimensions	Φ97.1 mm × 93.0 mm (Φ3.82" × 3.66")				
Net Weight	0.17 Kg (0.37lb)				
Gross Weight	0.23 Kg (0.51lb)				

Ordering Information			Accessories		
Type	Part Number	Description	Optional:		
2MP Camera	DH-HAC-HDW1200TRQP 2.8 mm	2MP HDCVI IR Eyeball Camera, PAL			
	DH-HAC-HDW1200TRQP 3.6 mm		PFA13G Junction Box	PFB205W Wall Mount Bracket	PFA152-E Pole Mount Bracket (For use with PFB205W)
	DH-HAC-HDW1200TRQN 2.8 mm	2MP HDCVI IR Eyeball Camera, NTSC			
	DH-HAC-HDW1200TRQN 3.6 mm		PFA130-E Junction box	PFM800-E Passive HDCVI Balun	PFM321D 12V 1A Power Adapter
	DH-HAC-HDW1200TRQP-A 2.8 mm	2MP HDCVI IR Eyeball Camera, PAL			
	DH-HAC-HDW1200TRQP-A 3.6mm		PFM820 UTC Controller	PFM904 Integrated Mount Tester	
	DH-HAC-HDW1200TRQN-A 2.8mm				
	DH-HAC-HDW1200TRQN-A 3.6mm				
Accessories	PFA13G	Junction Box			
	PFB205W	Wall Mount Bracket			
	PFA152-E	Pole Mount Bracket (For use with PFB205W)			
	PFA130-E	Junction box			
	PFM800-E	Passive HDCVI Balun			
	PFM321D	12V 1A Power Adapter			
	PFM820	UTC Controller			
	PFM904	Integrated Mount Tester			

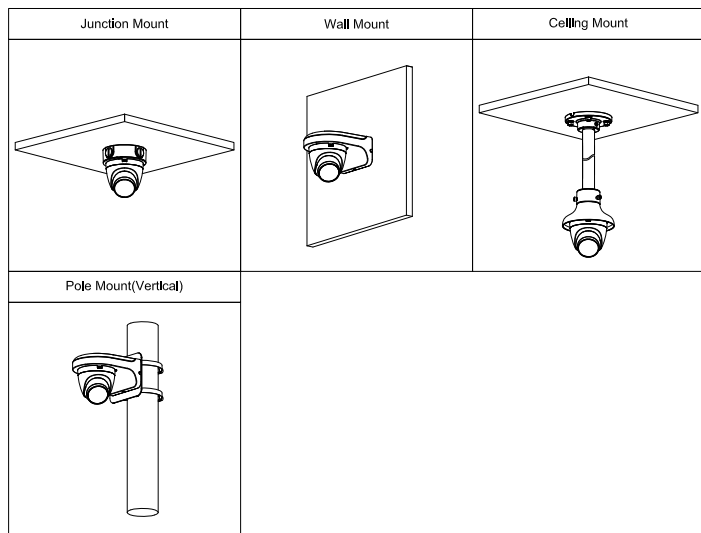

**Dimensions (mm[inch])**

